



NWD-2VF-XP

2MP Smart IR WDR Motor Dome Network Camera



Key Features:

- 1/2.8" Progressive Scan CMOS
- Motorised 2.7-13.5mm Lens
- 25fps/30fps@2MP(1920*1080)
- Triple Stream Output
- Smart IR 2.0 Up to 30m
- Low bitrate, Excellent low light performance
- 120dB WDR, 3D DNR
- Intelligent Video Analytics (IVA)
- ROI, Defog, HLC, Corridor mode, DIS
- IP67,IK10

Product Overview

Infinity Network Cameras support the latest H.265 encoding technology, bringing high efficient video compression and maintaining quality. It saves network bandwidth and storage, whilst being energy-saving design to enhance the surveillance system. This range has world-leading features such as Smart IR technology, PoE and intelligent video analytics techniques. Infinity cameras produce excellent image quality and intelligent and efficient event reminders as well as IP67 weatherproof and IK10 vandal-proof.

Features

Wide Dynamic Range

Embedded with industry leading wide dynamic range (WDR) technology, vivid pictures are achieved in even the most intense contrast lighting conditions. For applications with both bright and low lighting conditions that change quickly, true WDR (120dB) optimizes both the bright and dark areas of a scene at the same time to provide usable video.

Intelligent Video Analytics (IVA)

With built-in intelligent video analytics, the camera has the ability to detect and analyze moving objects for improved video surveillance. The camera provides optional standard intelligence at the edge allowing detection of Perimeter, Single Virtual Fences, Double Virtual Fences, Loitering, Multiple Loiterers, Objects Abandoned, Objects Removed, Abnormal Speed, Converse, Illegal Parking, Bad Signal.

Environmental

With a temperature range of -40 °C to +60 ° the camera is designed for extreme temperature environments. Subjected and certified to rigorous dust and water immersion tests, the IP67 rating makes it suitable for demanding outdoor applications.

Smart Encode (H.265+)

Deliver high quality video without straining the network, Smart Encode H.265+ is the optimized implementation of H.265. The Smart H.265+ encoding technology includes a scene adaptive encoding strategy, dynamic GOP, dynamic ROI, flexible multi-frame reference structure and intelligent noise reduction, providing saving of up to 70% of bandwidth and storage when compared with standard H.265.

HEVC (H.265)

H.265 ITU-T VCEG is a new video coding standard. H.265 Following standard developed around the existing video coding standard H.264, some retain the original technology, while some of the relevant technology to improve the new technology uses advanced technology to improve the relationship between the code stream, encoding quality, and the delay between algorithm complexity, optimize settings specific contents include: Improve compression efficiency, improve the robustness and error recovery capabilities, real-time to reduce the delay, reduce channel acquisition time and a random access delay, reduce complexity.

Technical Specification

Camera	
Image Sensor	1/2.8" Progressive Scan CMOS
Effective Pixels	1920(H)×1080(V)
Scanning System	Progressive
Electronic Shutter	1/5-1/20000s
Min. illumination	Color:0.01Lux@(F1.2,AGC ON) , B/W:0Lux@(IR LED ON)
S/N Ratio	55dB
IR Range	Up to 40m
IR On/Off Control	Auto/ Manual
IR LEDs	15pcs
Pan/Tilt/Rotation Range	Pan:0°~355°, Tilt:0°~80°, Rotation: 0°~355°
Lens	
Lens Type	Motor
Iris	Auto Iris
Focal Length	2.7mm – 13.5mm
F Number	F1.2
Angle of View	101°~28°
Focus Control	Motor
Close Focus Distance	0.2m
Video	
Compression	H.265,H.265,MJPEG
Max. Resolution	1080P(1920×1080)
Streaming Capability	3 Streams
Stream / Frame Rate	Stream1: 1920×1080/1280×720 @25/30fps Stream2: D1/VGA/640×360/CIF/QVGA @25/30fps Stream3: VGA/CIF/QVGA @25/30fps
Bit Rate Control	CBR/VBR
Bit Rate	Stream1: 200kbps~12000kbps Stream2: 100kbps~6000kbps Stream3: 100kbps~3000kbps
Day/Night	ICR
Image Enhancement	HLC / Defog / WDR (120dB) / BLC / Anti-shake
White Balance	Support
Gain Control	Auto/Manual
Noise Reduction	2D/3D DNR
Image Stabilize	Support
Smart IR	Support Smart IR 2.0
Mirror	Support

Region of Interest	Support
Motion Detection	Support
Privacy Masking	Support
Audio	
Compression	G.711, RAW_PCM
Bit Rate	8~64Kbps (G.711)
Network	
Protocols:	IPv4/IPv6, 802.1x, HTTP, HTTPS, TCP/IP, UDP/IP, RTSP, DHCP, NTP, RTCP/RTP, PPPoE, SMTP, DNS, UPnP, FTP, ARP, SNMP
Interoperability	ONVIF
Streaming Method	Unicast
Max. User Access	10 Users
Web Viewer	<IE11, Chrome, Firefox
Management Software	Infinity IMS
Smart Phone	IOS, Android
Intelligence	
IVS	Perimeter, Single/Double Virtual Fences, Single Loiter, Multi Loiterer, Object Abandoned, Object Removed, Abnormal Speed, Converse, Illegal Parking, Signal Bad
Interface	
Ethernet	1 Ethernet (10/100 Base-T) RJ-45 Connector
Audio Interface	1x Input / 1x Output
Alarm	1x Input / 1x Output
RS485	N/A
BNC Output	N/A
Reset Button	Support
Edge Storage	Micro SD Card support up to 256GB
Electrical	
Power Supply	DC12V / PoE
Power Consumption	5W(IR LED OFF), 8W (IR LED ON)
Operating Temperature	-40°C ~ 60°C
Operating Humidity	Less than 90% RH
Ingress Protection	IP67, IK10
Certifications	CE / FCC
Casing	Metal
Dimensions	φ 130×112mm
Net Weight	800g

Dimensions(mm)

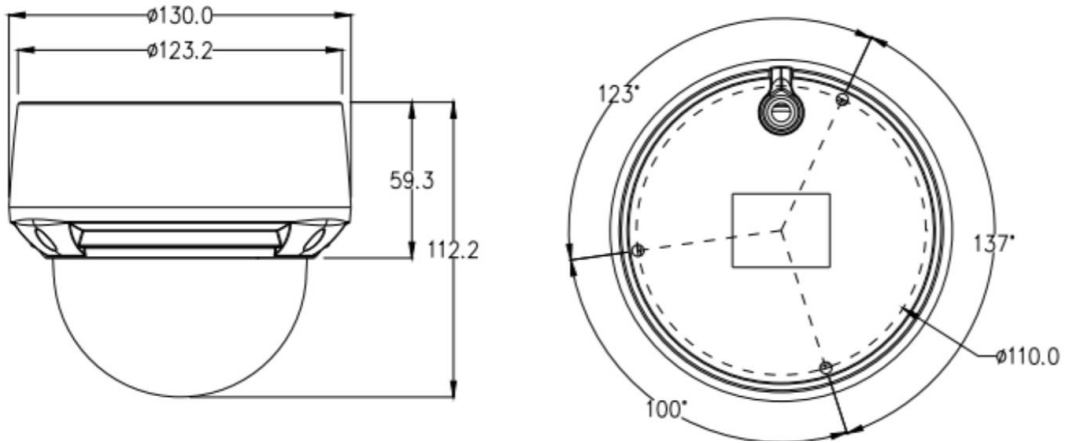

Accessories

Optional:



NWD-JBVF
Junction Box



NWD-WBVF
Wall Mount