



NWPU-225-iXP

2MP 25x Zoom 150m IR A.I Intelligent Analytics Network PTZ Camera



Key Features:

- 1/2.8" Progressive Scan CMOS
- 25x Optical Zoom; 16x Digital Zoom
- 25fps/30fps@2MP(1920*1080)
- Multi Stream Output
- Smart IR 2.0 Up to 150m
- Low bitrate, Excellent low light performance
- 120dB+ WDR, 3D DNR, BLC, HLC, AGC
- Intelligent Video Analytics (IVA)
- Auto Tracking
- IP67, IK10

Product Overview

Infinity PTZ Cameras support the latest H.265 encoding technology, bringing high efficient video compression and maintaining quality. It saves network bandwidth and storage, whilst being energy-saving design to enhance the surveillance system. The range supports Auto Tracking, Smart IR and intelligent video analytics techniques. Infinity cameras produce excellent image quality and intelligent and efficient event reminders as well as IP67 weatherproofing.

Features

Auto Tracking

Advanced intelligence allowing the camera to monitor and follow a detection object that poses a threat. Wherever the object moves whilst remaining in view, the camera will automatically move and zoom in to ensure the object remains in close-quarter surveillance view.

Intelligent Video Analytics (IVA)

With built-in intelligent video analytics, the camera has the ability to detect and analyze moving objects for improved video surveillance. The camera provides optional standard intelligence at the edge allowing detection of Perimeter, Single Virtual Fences, Double Virtual Fences, Loitering, Multiple Loiterers, Objects Abandoned, Objects Removed, Abnormal Speed, Converse, Illegal Parking, Bad Signal.

Environmental

With a temperature range of -55 °C to +60 ° the camera is designed for extreme temperature environments. Subjected and certified to rigorous dust and water immersion tests, the IP67 rating makes it suitable for demanding outdoor applications.

Smart Encode (H.265+)

Deliver high quality video without straining the network, Smart Encode H.265+ is the optimized implementation of H.265. The Smart H.265+ encoding technology includes a scene adaptive encoding strategy, dynamic GOP, dynamic ROI, flexible multi-frame reference structure and intelligent noise reduction, providing saving of up to 70% of bandwidth and storage when compared with standard H.265.

HEVC (H.265)

H.265 ITU-T VCEG is a new video coding standard. H.265 Following standard developed around the existing video coding standard H.264, some retain the original technology, while some of the relevant technology to improve the new technology uses advanced technology to improve the relationship between the code stream, encoding quality, and the delay between algorithm complexity, optimize settings specific contents include: Improve compression efficiency, improve the robustness and error recovery capabilities, real-time to reduce the delay, reduce channel acquisition time and a random access delay, reduce complexity.

Technical Specification

Camera	
Image Sensor	1/2.8" BSI & NIR++ Progressive Scan CMOS
Effective Pixels	1920(H)x1080(V)
Scanning System	Progressive
Electronic Shutter	1/1-1/10000s
Min. illumination	Color:0.000125Lux@(F1.2,AGC ON) , B/W:0Lux@(IR LED ON)
S/N Ratio	55dB
IR Range	Up to 150m
IR On/Off Control	Auto/ Manual
Pan/Tilt/Rotation Range	Pan: 0° ~ 360° endless, Tilt: -10° ~ +90°

Lens	
Lens Type	Motor
Focal Length	4.8-120mm
Optical Zoom	25x
Digital Zoom	16x
Angle of View	Horizontal 55° ~ 2.4° / Vertical 33° ~ 1.4°
Focus Control	Auto/Manual

Video	
Compression	H.265,H.265,MJPEG
Max. Resolution	1080P(1920x1080)
Streaming Capability	Up to 5 streams
Stream / Frame Rate	Main Streams: 1920x1080/1280x720 @ 25/30fps Sub Streams: VGA/CIF/QVGA @ 25/30fps Third Stream: QVGA @ 25/30fps
Bit Rate Control	CBR/VBR
Bit Rate	64kbps~16000kbps
Auto Tracking	Support
Image Enhancement	HLC / Defog / WDR / AGC (Auto/Manual) / Image Stabilize / 2D & 3D DNR
White Balance	Auto/Tungsten/Fluorescent/Daylight/Shadow/Manual
Smart IR	Support Smart IR 2.0
Advanced Features	Mirror, 8x Region of Interest zones, 4x Privacy Masks, Motion Detection, 360 Presets, 8 Tours

DORI				
Focal Length	Detect	Observe	Recognize	Identify
f=4.8mm	90m	40m	20m	9m
f=120mm	2100m	800m	380m	180m

*environmental conditions, installation and camera positioning and other factors can affect camera performance against these figures

PTZ and Audio	
Preset Speed	Pan: 240° /s, Tilt: 240° /s
Manual Control	Pan: 0.1° ~240° /s, Tilt: 0.1° ~240° /s
PTZ Mode / Idle	8 Track, 16 Tour, 16 Scan, with 8 manual speed settings, Idle: Activate Preset/ Scan/ Tour/ Track if there is no command in the specified period
Compression	G.711, RAW_PCM
Bit Rate	64Kbps (G.711), 128kbps (RAW_PCM)

Network	
Protocols:	IPv4/IPv6, 802.1x, HTTP, HTTPS, TCP/IP, UDP/IP, RTSP, DHCP, NTP, RTPC/RTP, PPPoE, SMTP, DNS, UPnP, FTP, ARP, SNMP
Interoperability	ONVIF
Streaming Method	Unicast
Max. User Access	10 Users
Web Viewer	<IE11, Chrome, Firefox
Management Software	Infinity VMS Lite/VMS Free
Smart Phone	IOS, Android

Intelligence	
IVS	Perimeter, Single/Double Virtual Fences, Single Loiter, Multi Loiterer, Object Abandoned, Object Removed, Facial Recognition, Signal Bad

Interface	
Ethernet	1 Ethernet (10/100 Base-T) RJ-45 Connector
Audio Interface	1x Input, 1x Output
Alarm	1x Input, 1x Output
RS485	Support
BNC Output	Support
Reset Button	Support
Storage	NAS, Local PC, Local SDHC (Max 256GB)

Electrical	
Power Supply	12V DC / PoE+
Power Consumption	22W
Operating Temperature	-55°C ~ 60°C
Operating Humidity	Less than 90% RH
Ingress Protection	IP67, IK10, 6000V Lightning Protection
Certifications	CE / FCC
Casing	Metal
Dimensions	Φ 268x173mm
Net Weight	2.1Kg

Dimensions(mm)

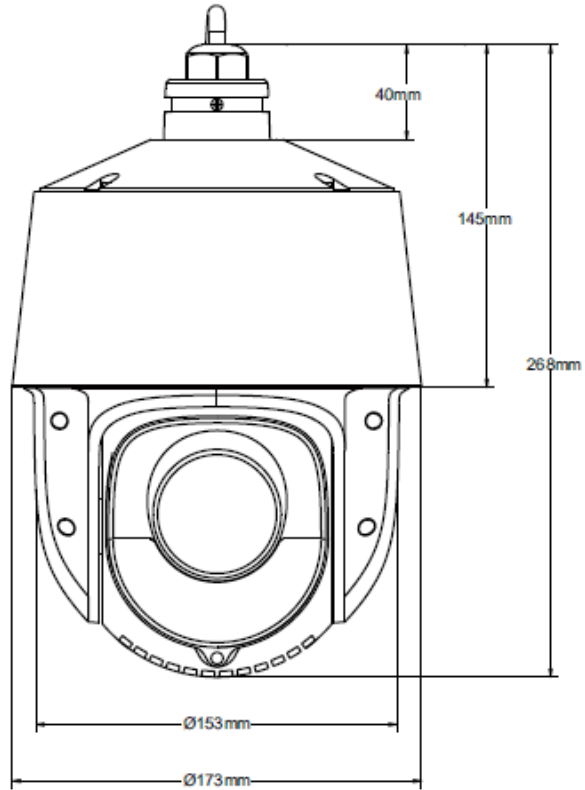

Accessories

Optional:



NWP-WB
Wall Mount



NWP-CMM
Ceiling Mount



NWP-CM
Corner Mount



NWP-PLM
Pole Mount